

Hygoair®

ULTRAVIOLET INDIRECT AIR DISINFECTION



Model LIND24-EVO-2PM



Model LIND24-EVO

ADVANTAGES

Economical

System requires very little power to operate.

Safe

Low risk of over-exposure.

Fast

Disinfects air in seconds, reducing the risk of cross infection and exposure of occupants to infectious airborne microbes.

Automatic

Continuous disinfection without special attention.

Durable

Polished Stainless Steel and Aluminum construction.

Versatile

Two styles available to handle different room configurations.

Low Maintenance

Annual lamp replacement and periodic cleaning is all that is required.

PRINCIPLE OF OPERATION

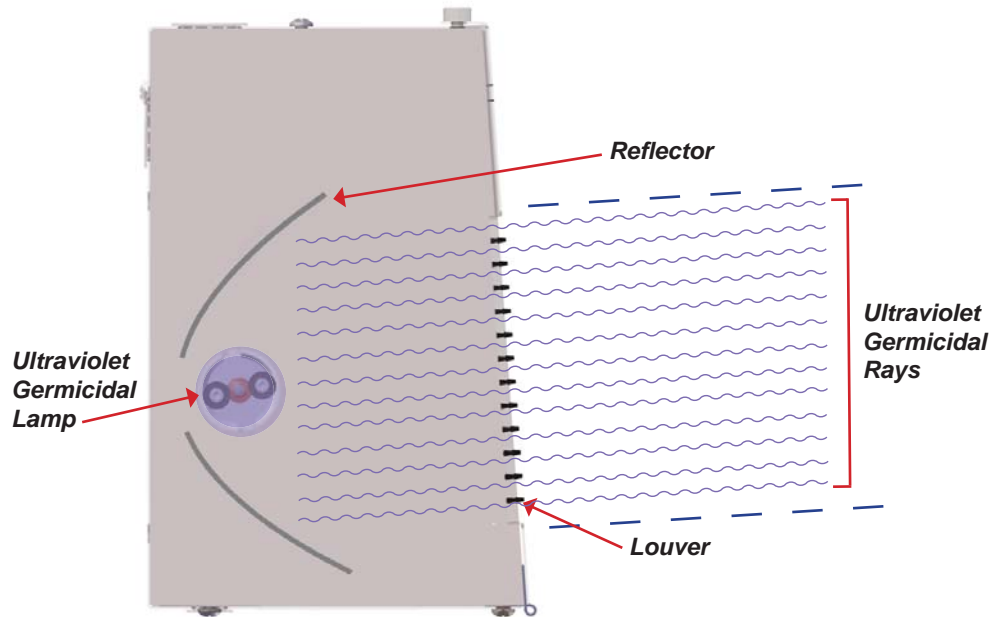

Model LIND24-EVO
Wall Mount, Single Lamp

The **Hygeaire**[®] design has been carefully conceived to direct germicidal ultraviolet rays to purify the upper room air of occupied spaces in order to reduce the risk of cross infection and exposure of occupants to infectious airborne microbes.

The operation of the **Hygeaire**[®] is as follows:

1. Ultraviolet rays project across the upper room air.
2. Bacteria and viruses that are carried into the ultraviolet field by convection currents or air circulation are destroyed.
3. The air in the room is continuously being purified.

Hygeaire® LIND24-EVO Wall Mount Indirect Unit

Surelite™ Electronic Ballast

State-of-the-art electronic ballasts are designed to operate ultraviolet lamps. The Hygeaire® unit includes a unique variable output version of the Surelite™ with an adjustable feature mounted to base of the fixture.

The Surelite™ Electronic Ballast offers these advantages over conventional ballasts:

- delivers higher uv lamp output
- instant starting
- eliminates "stroboscopic effect"
- small and lightweight
- operates cooler for longer life
- versatile... each operates a wide range of lamps
- saves energy through higher efficiency
- provides silent operation
- variable ultraviolet output adjustment feature

Safety Interlock Switch

Switch protects field technicians from exposure to ultraviolet radiation by automatically disconnecting power to the lamp when fixture is opened.

Stainless Steel Construction

The unit is manufactured in Type 304 stainless steel for unparalleled strength, durability and an attractive finish.

Polished Reflector

Interior surface includes a special polished reflector which provides a highly reflective surface to maximize ultraviolet intensity.

STER-L-RAY® Slimline Germicidal Lamp

Lamp is instant starting and provides the utmost in quality, sustained output and longevity. (see page 8 for information)

Steadfast™ Lampholder

Set includes a stationary and a spring-loaded, telescopic holder that holds a single pin lamp securely. The spring-loaded feature on one end facilitates convenient, quick and easy lamp changes.

Louvers

Unique construction directs ultraviolet rays to the upper portion of the room.

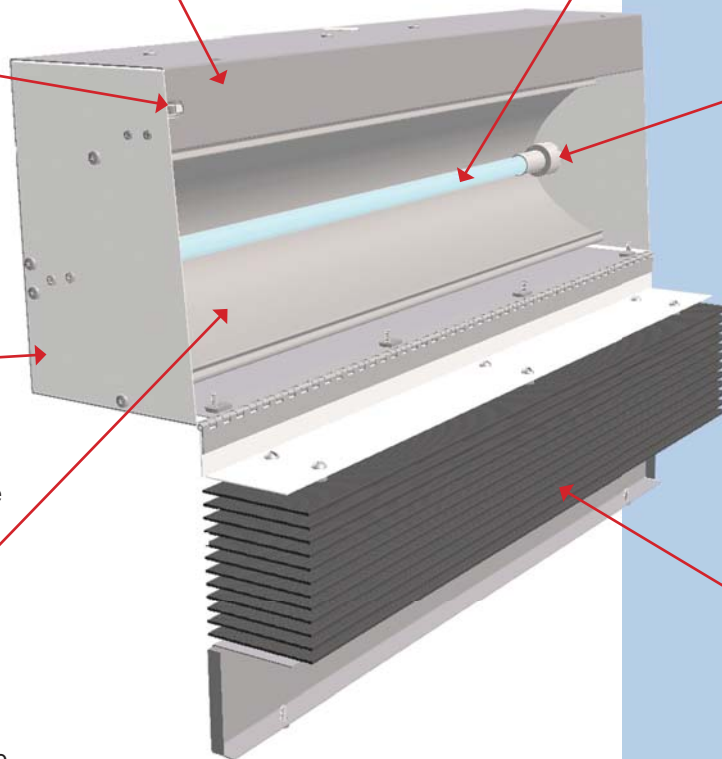

Model LIND24-EVO
Wall Mount, Single Lamp

(see page 8 for Optional Accessories)

INSTALLATION

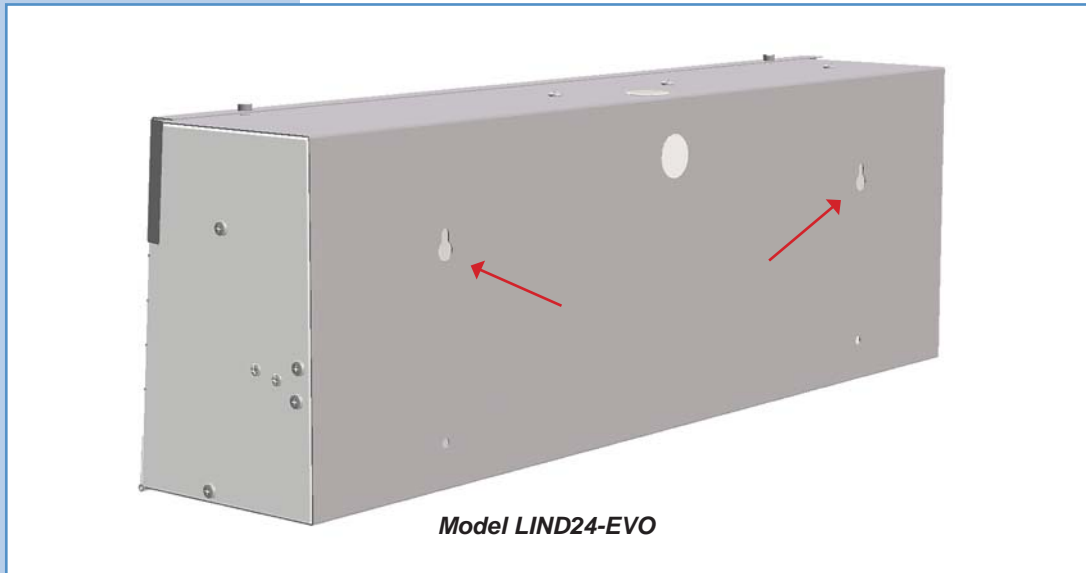

Figure 1 - Shows the back side of **Hygeaire® Model LIND24-EVO**; note the two mounting holes in the back of the unit. The fixture is to be mounted on a plumb and vertical surface, at a minimum height of 7 feet from the bottom of the fixture to the floor, in a location that must be able to safely support 16 pounds.

SPECIFICATIONS - Hygeaire® LIND24-EVO Wall Mount Indirect Unit

Model	Lamp	Power Consumption ^①	Total Ultraviolet Output ^②	Exterior Housing Dimensions			Rated Average Lamp Life
				Length	Width	Depth	
LIND24-EVO	05-1348-R (1)	30.7 Watts	8.5 Watts	24"	5-11/32"	7-7/8"	10,000 Hours

① Wattage is Lamp Watts and ballast loss (approximate).

② Output at 254 nanometers at 100 hours and 80 degrees F (approximate).

- 120 Volts 50/60 Hz and 220-230 Volts 50/60 Hz units are available - specify when ordering.
- Consult factory with other specific power requirements.
- Bottom of unit must be installed at a minimum height of 7 feet above the floor, see page 11 for more information.

Hygeaire® LIND24-EVO-2PM Pendant Mount Indirect Unit

Surelite™ Electronic Ballast

State-of-the-art electronic ballasts are designed to operate ultraviolet lamps. The Hygeaire® unit includes two unique variable output versions of the Surelite™ with an adjustable feature mounted to base of the fixture.

The Surelite™ Electronic Ballasts offers these advantages over conventional ballasts:

- deliver higher uv lamp output
- eliminate “stroboscopic effect”
- operate cooler for longer life
- saves energy through higher efficiency
- variable ultraviolet output adjustment feature
- instant starting
- small and lightweight
- versatile... each operates a wide range of lamps
- provide silent operation

Safety Interlock Switch

Switch protects field technicians from exposure to ultraviolet radiation by automatically disconnecting power to the lamp when fixture is opened.

Stainless Steel Construction

The unit is manufactured in Type 304 stainless steel for unparalleled strength, durability and an attractive finish.

Polished Reflector

Interior surface includes a special polished reflector which provides a highly reflective surface to maximize ultraviolet intensity.

STER-L-RAY® Slimline Germicidal Lamp

Lamp is instant starting and provides the utmost in quality, sustained output and longevity. (see page 8 for information)

Steadfast™ Lampholder

Set includes a stationary and a spring-loaded, telescopic holder that holds a single pin lamp securely. The spring-loaded feature on one end facilitates convenient, quick and easy lamp changes.

Louvers

Unique construction directs ultraviolet rays to the upper portion of the room.

Pendant Mount Canopy Set

Secures Hygeaire® LIND24-EVO-2PM to surface (not shown, see photo on page 7, Figure 3)

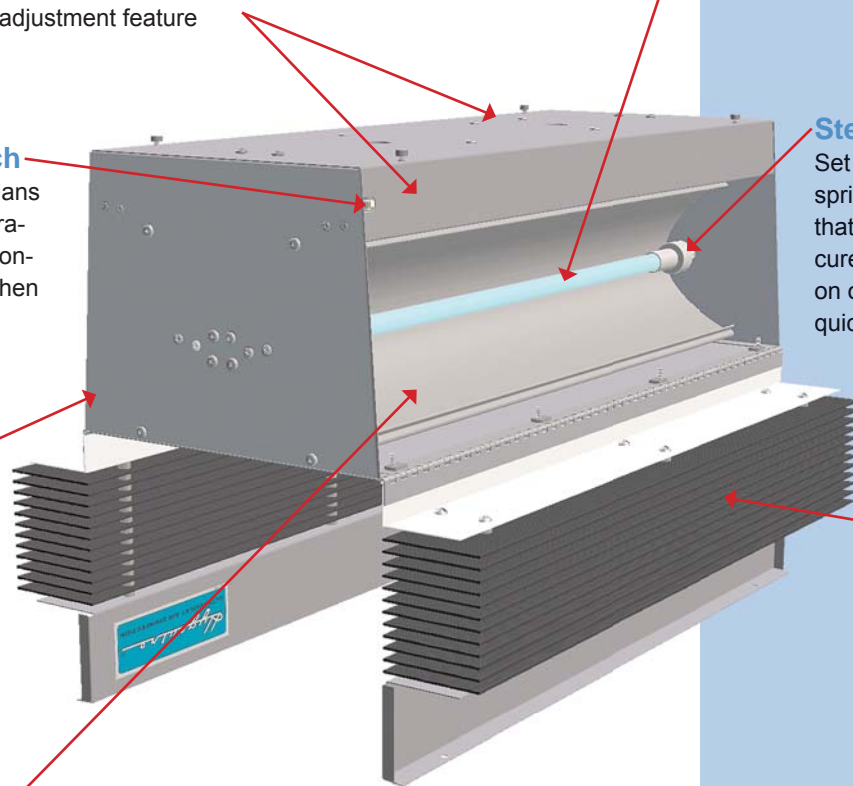

Model LIND24-EVO-2PM
Pendant Mount, Double Lamp

(see page 8 for Optional Accessories)

INSTALLATION

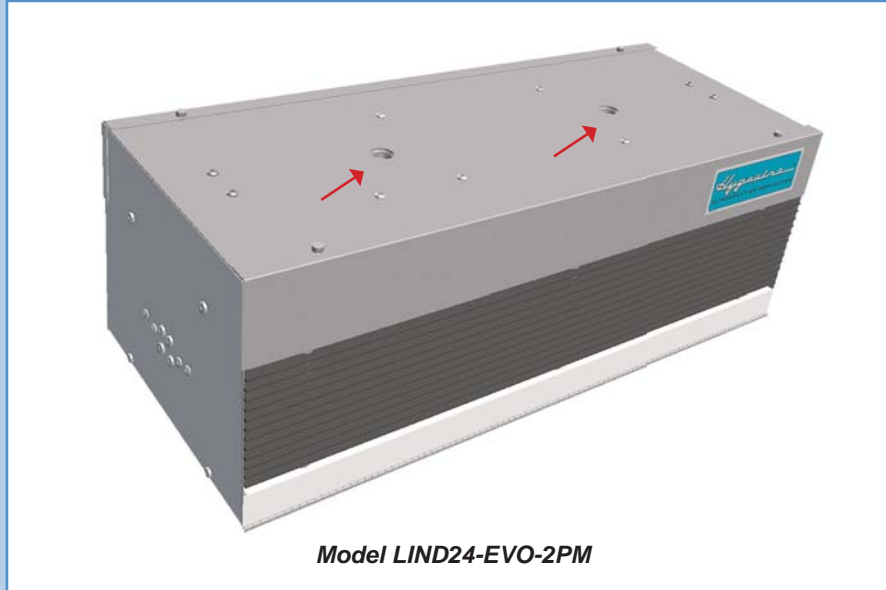

Figure 2 - Shows the top of **Hygeaire® Model LIND24-EVO-2PM** (above). Note the two mounting holes on the top of this unit (these are for the Pendant Mount Canopy Set attachment). The fixture is to be mounted at a minimum height of 7 feet from the bottom of the fixture to the floor, in a location that must be able to safely support 32 pounds.

Figure 3 - Shows **Hygeaire® Model LIND24-EVO-2PM** complete with Pendant Mount Canopy Set (left).

SPECIFICATIONS - Hygeaire® LIND24-EVO-2PM Pendant Mount Indirect Unit

Model	Lamp	Power Consumption ①	Total Ultraviolet Output ②	Exterior Housing Dimensions			Rated Average Lamp Life
				Length	Width	Depth	
LIND24-EVO-2PM	05-1348-R (2)	61.4 Watts	17 Watts	24"	10-17/32"	7-7/8"	10,000 Hours

① Wattage is Lamp Watts and ballast loss (approximate).

② Output at 254 nanometers at 100 hours and 80 degrees F (approximate).

- 120 Volts 50/60 Hz and 220-240 Volts 50/60 Hz units are available - specify when ordering.
- Consult factory with other specific power requirements.
- Bottom of unit must be installed at a minimum height of 7 feet above the floor, see page 11 for more information.

OPTIONAL ACCESSORIES



Zenith™ Ultraviolet Meter

A sensitive, hand-held, ultraviolet meter that can be used to:

- Survey installations to ensure that the germicidal ultraviolet radiant exposure of personnel within the treated area, is within acceptable limits. The Zenith™ Ultraviolet Meter provides accurate and easy-to-read levels of intensity that may be interpreted by anyone - not just engineers.
- Check the intensity of aging ultraviolet lamps



ArmorLite™ Safety Shield

Protective coating applied to **STER-L-RAY®** Germicidal Lamps ensures protection for employees, products and work environments by eliminating the dangers associated with fragments of broken lamps and mercury contamination. (Lamp on right has **Armorlite™** coating)

GENUINE **STER-L-RAY®** GERMICIDAL LAMPS

STER-L-RAY® Germicidal Lamps are shortwave, low pressure mercury vapor discharge tubes that produce ultraviolet wavelengths lethal to microorganisms. Approximately 95% of the ultraviolet energy emitted from **STER-L-RAY®** germicidal lamps is at the mercury resonance line of 254 nanometers, the region of germicidal effectiveness most destructive to bacteria, mold and virus.

STER-L-RAY® and the **STER-L-RAY®** logo are trademarks of Atlantic Ultraviolet Corporation.

CAUTION: Exposure to direct or reflected germicidal ultraviolet rays will cause painful eye irritation and reddening of the skin. Personnel subject to such exposure must wear suitable faceshield, gloves and protective clothing.



Slimline Germicidal Lamps

OPERATING CHARACTERISTICS

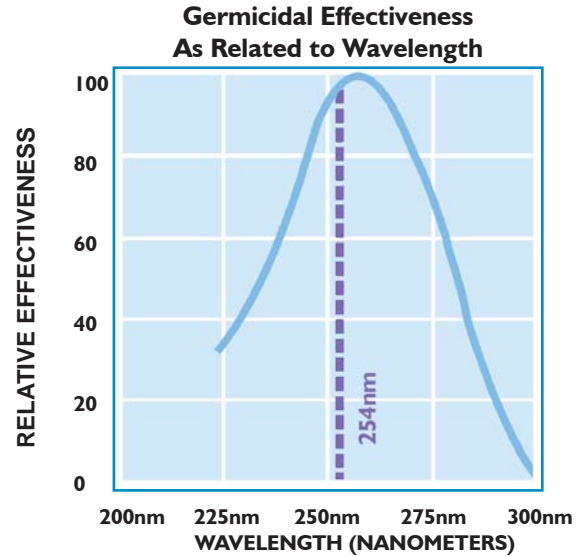
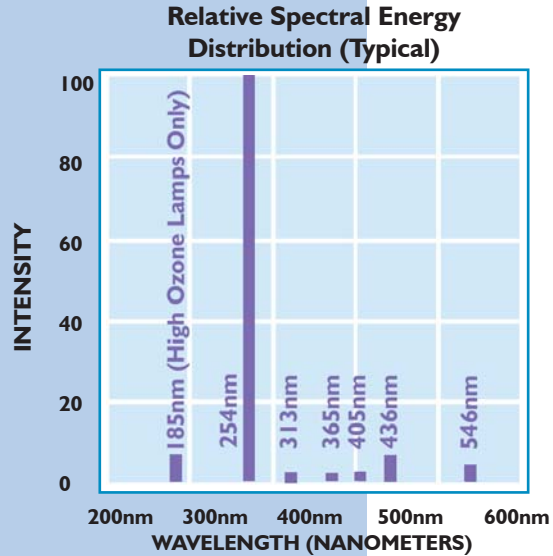

ULTRAVIOLET DOSAGE

Germicidal lamps provide effective protection against microorganisms. A small cross-section is shown below.

ORGANISM	ALTERNATE NAME	TYPE	DISEASE	DOSE*
<i>Corynebacterium diphtheriae</i>	<i>C. diphtheriae</i>	Bacteria	Diphtheria	6,500
<i>Legionella pneumophila</i>	<i>L. pneumophila</i>	Bacteria	Legionnaire's Disease	2,700
<i>Mycobacterium tuberculosis</i>	<i>M. tuberculosis</i>	Bacteria	Tuberculosis (TB)	10,000
<i>Pseudomonas aeruginosa</i>	<i>P. aeruginosa</i>	Bacteria		3,900
<i>Serratia Marcescens</i>	<i>S. marcescens</i>	Bacteria		6,160
<i>Staphylococcus aureus</i>	<i>S. aureus</i>	Bacteria		6,600
<i>Staphylococcus epidermidis</i>	<i>S. epidermidis</i>	Bacteria		5,800
Adeno Virus Type III		Virus		4,500
Coxsackie A2		Virus		6,300
Influenza		Virus	Flu	3,400

* Nominal Ultraviolet dosage ($\mu\text{WSec}/\text{cm}^2$) necessary to inactivate better than 99% of specific microorganism. Consult factory for more complete listing.

APPLICATIONS

The principal application of **Hygeaire**[®] germicidal ultraviolet is to purify the upper room air in occupied spaces in order to reduce the risk of cross infection and exposure of occupants to infectious airborne microbes. These fixtures are designed to project the ultraviolet rays across the upper room air thereby destroying bacteria and viruses that are carried into the ultraviolet field by convection currents or air circulation.

It is an important requirement when applying indirect germicidal ultraviolet irradiation to upper air to keep the radiation in the occupied level (below 6-1/2 feet) within acceptable limits. Therefore, mounting in the appropriate position is essential for safe use.

Our Ultraviolet Application Specialists are here to help you determine the best location for the installation of the **Hygeaire**[®].

As with all indirect ultraviolet fixtures, occasional ultraviolet measurements are required to ensure that ultraviolet intensities within the occupied area remain at the maximum treatment levels without exceeding the safety limits.

The **Hygeaire**[®] fixture includes a variable output ballast, providing an adjustment to comply with the safety standard.

Our **Zenith**[™] Ultraviolet Meter is an optional accessory (described on page 8). However we feel that it is a necessary tool to ensure that the ultraviolet radiation levels are optimized for treatment and safety purposes.

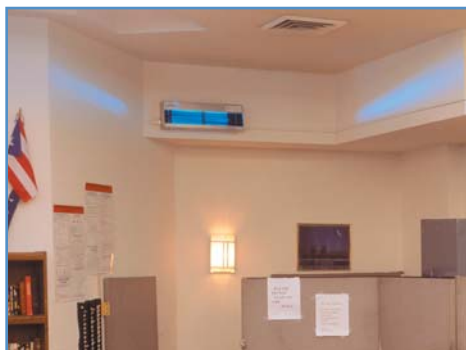
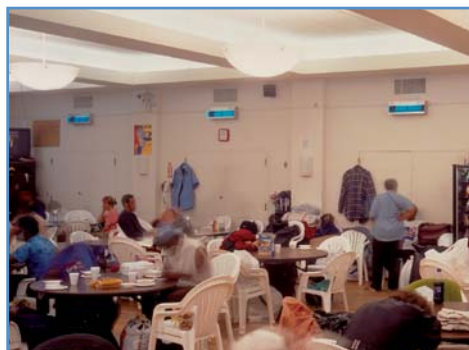

- laboratories
- hospitals
- clinics
- maternity areas
- labor & delivery areas
- pathology labs
- kidney dialysis labs
- operating rooms
- methadone clinics
- burn centers
- TB clinics
- homeless shelters
- prisons and jails
- detention centers
- nursing homes
- universities
- schools
- veterinary clinics
- animal husbandry
- kennels
- food industry
- food processing
- dairy processing
- bakeries
- office buildings
- conference rooms
- clean rooms
- pharmaceutical mfg.
- electronic production
- cosmetic production

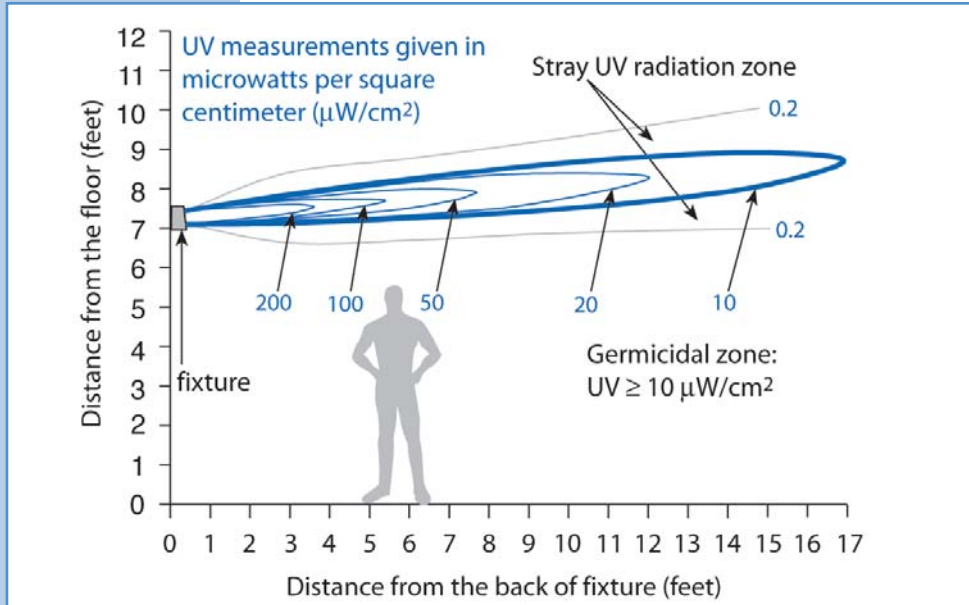

Figure 4

Distribution of UV radiation from **Hygeaire® Model LIND24-EVO** wall mounted unit

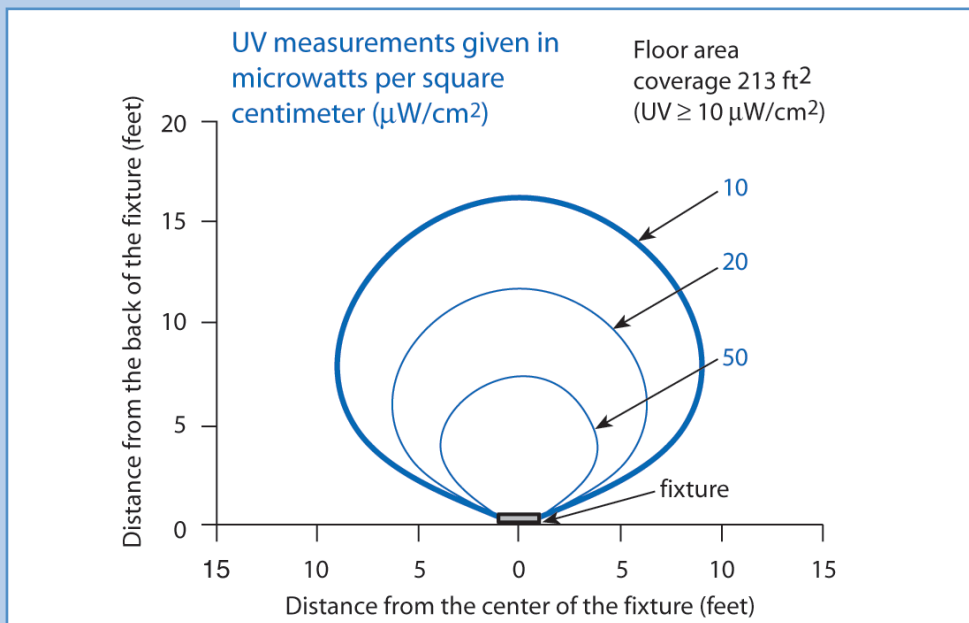

Figure 5

Example of the coverage area of the **Hygeaire® Model LIND24-EVO** wall mounted unit